



# Installation instructions, accessories

Volvo Car Corporation Gothenburg, Sweden

<b>Instruction No</b>	<b>Version</b>	<b>Part. No.</b>
31414797	1.0	31414791, 31414794, 31414793, 31414792, 39842094, 39842095, 39842096, 39842097

## Steering wheel



# Installation instructions, accessories

Volvo Car Corporation Gothenburg, Sweden

## Equipment



IMG-239667



IMG-239664

**Nm**  
**lbf.ft**



IMG-239945

A



B

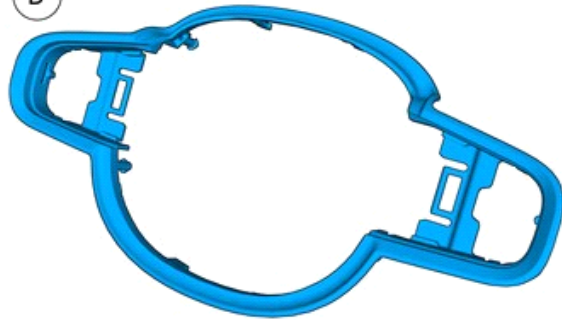

C

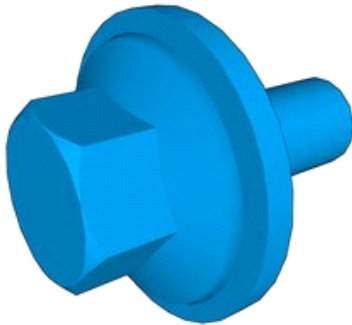

IMG-396151



# Installation instructions, accessories

Volvo Car Corporation Gothenburg, Sweden

## Information

1

Read through all of the instructions before starting installation.

Notifications and warning texts are for your safety and to minimise the risk of something breaking during installation.

Ensure that all tools stated in the instructions are available before starting installation.

Certain steps in the instructions are only presented in the form of images. Explanatory text is also given for more complicated steps.

In the event of any problems with the instructions or the accessory, contact your local Volvo dealer.

## Color symbols

2

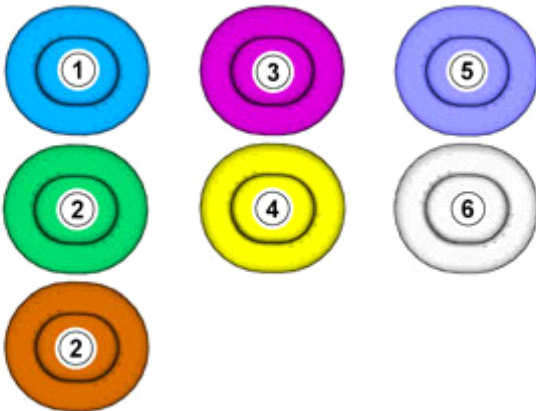

IMG-363036

### Note!

This colour chart displays (in colour print and electronic version) the importance of the different colours used in the images of the method steps.

1. Used for focused component, the component with which you will do something.
2. Used as extra colors when you need to show or differentiate additional parts.
3. Used for attachments that are to be removed/installed. May be screws, clips, connectors, etc.
4. Used when the component is not fully removed from the vehicle but only hung to the side.
5. Used for standard tools and special tools.
6. Used as background color for vehicle components.

## Removal



# Installation instructions, accessories

Volvo Car Corporation Gothenburg, Sweden

3



IMG-394535

4

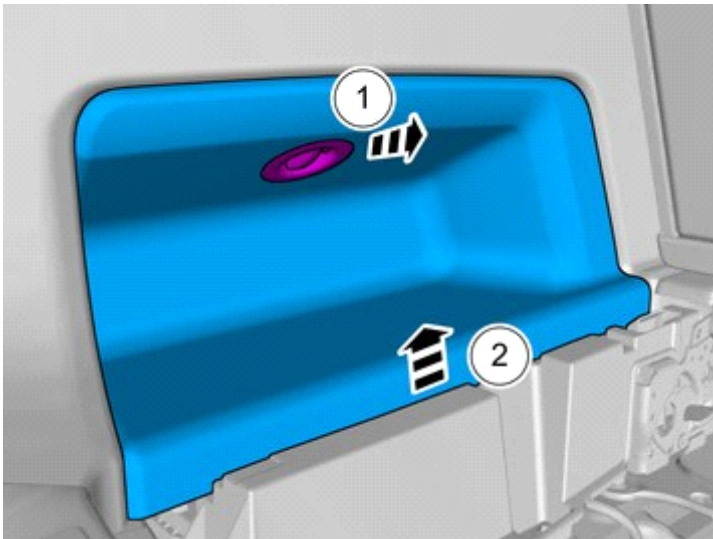

IMG-387004

5

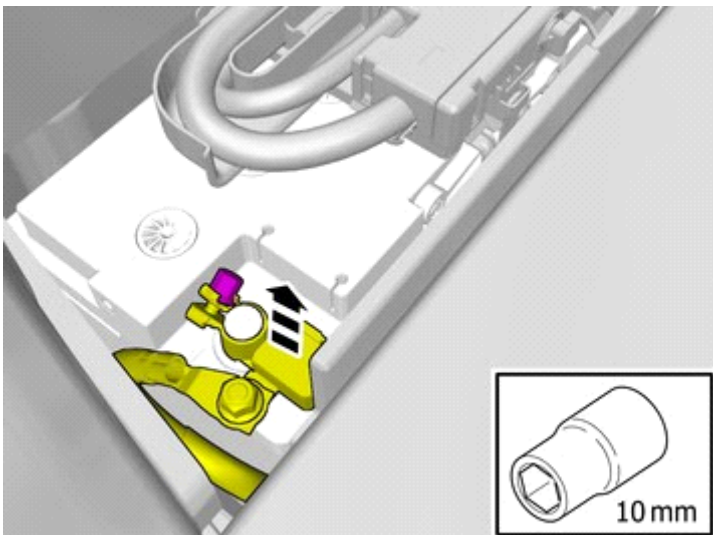

IMG-394520

Remove the battery's negative cable.



# Installation instructions, accessories

Volvo Car Corporation Gothenburg, Sweden

6

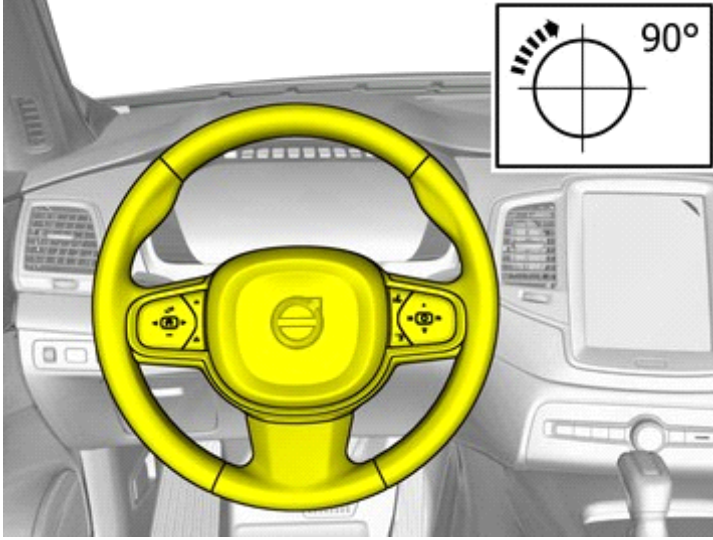

IMG-395203

7

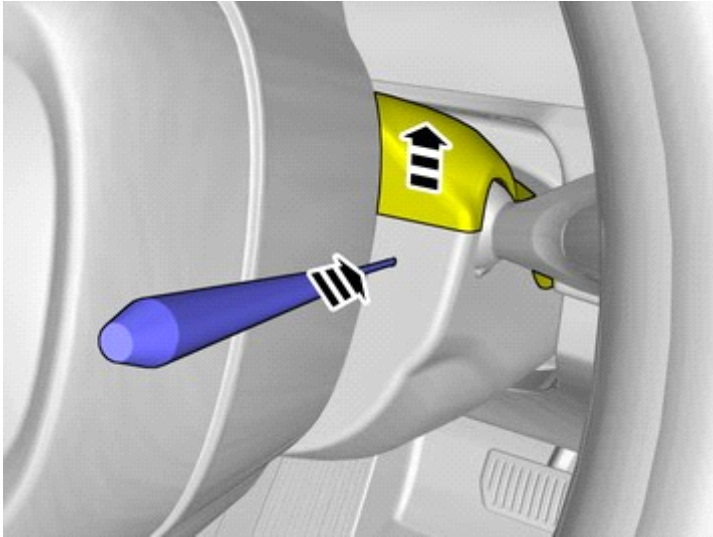

IMG-395231

Release the lock.

8

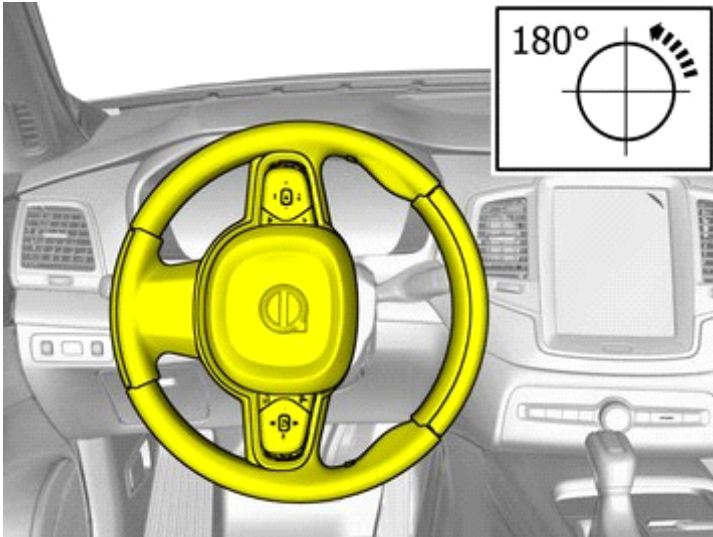

IMG-395232



# Installation instructions, accessories

Volvo Car Corporation Gothenburg, Sweden

9

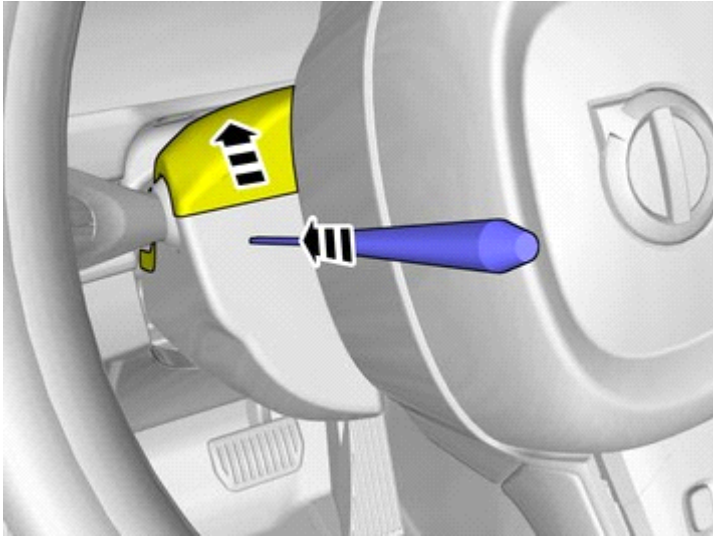

IMG-395236

Release the lock.

10



IMG-395252



# Installation instructions, accessories

Volvo Car Corporation Gothenburg, Sweden

11

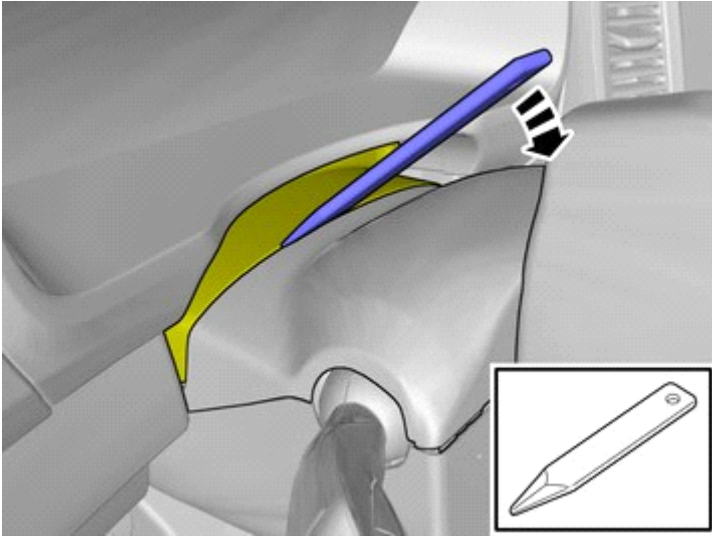

IMG-395250

Detach the panel.

12

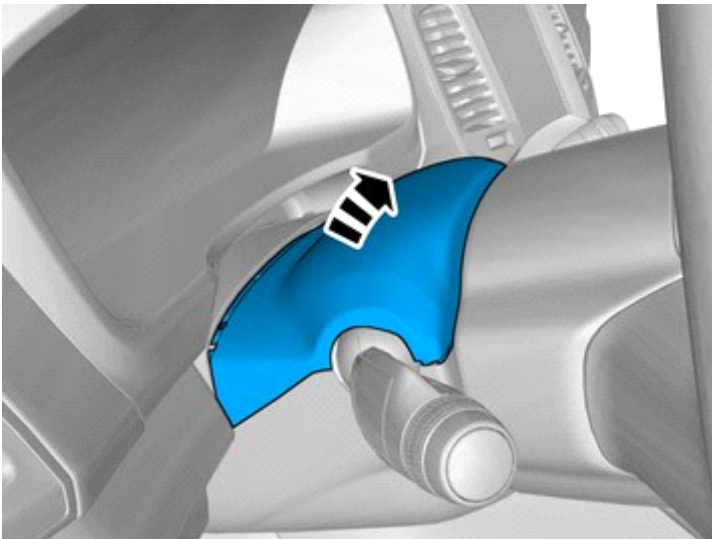

IMG-395260

Remove the marked part.

13

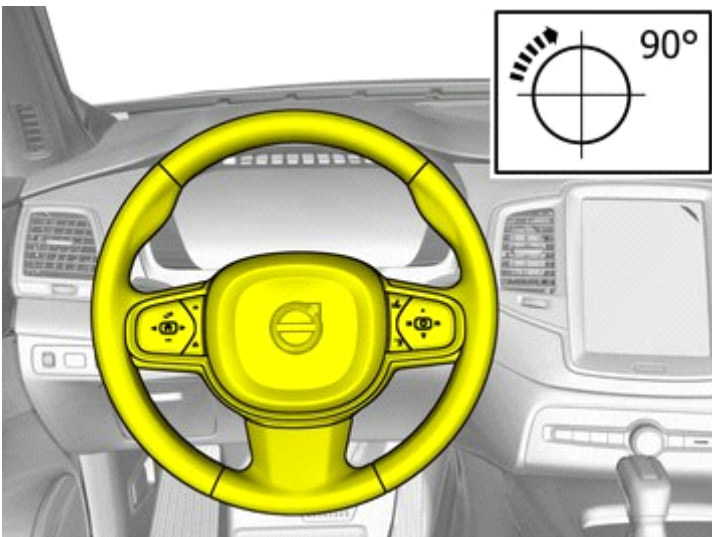

IMG-395203



# Installation instructions, accessories

Volvo Car Corporation Gothenburg, Sweden

14

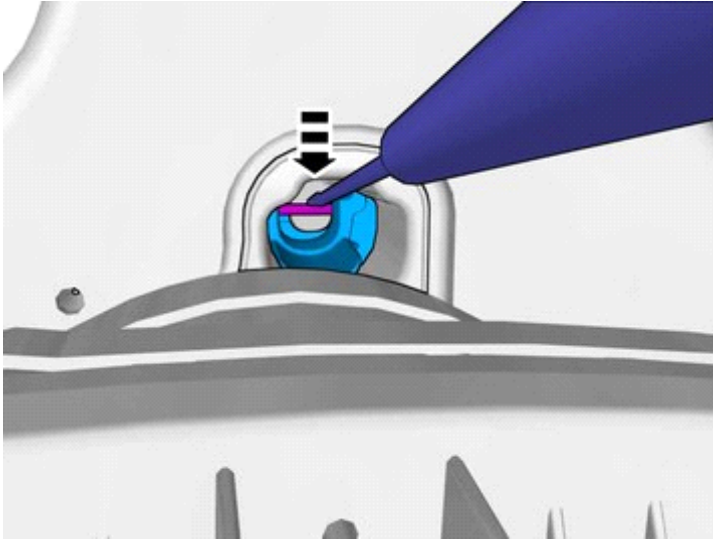

IMG-395375

Release the lock.

15

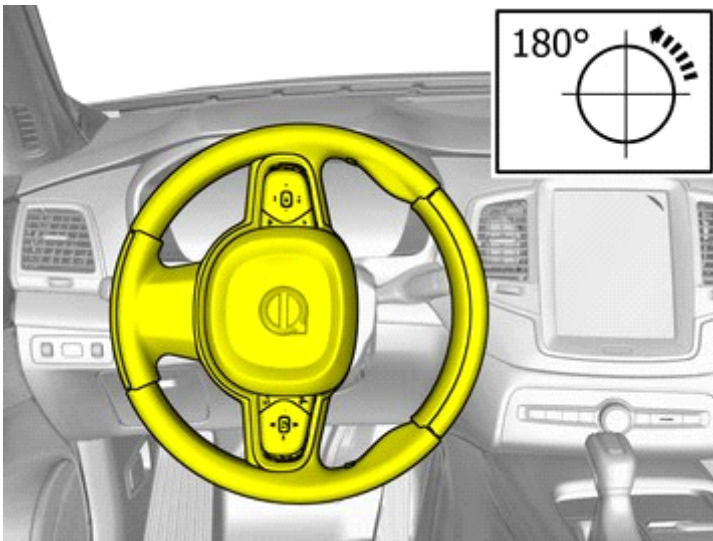

IMG-395232

16

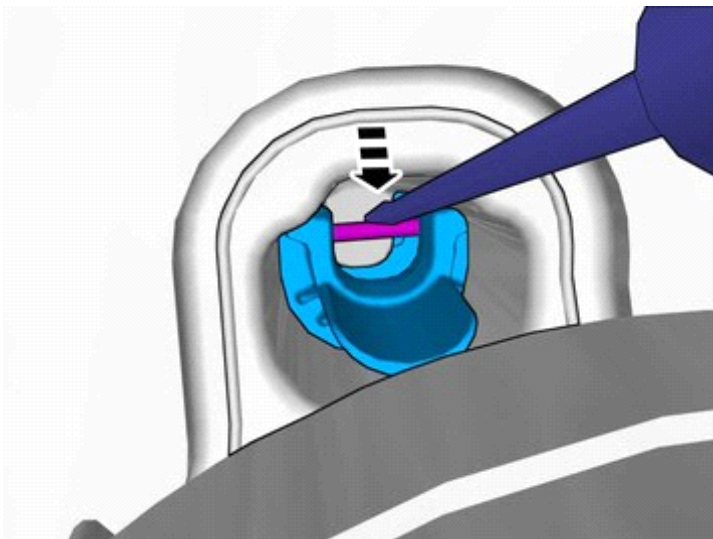

IMG-395391

Release the lock.





# Installation instructions, accessories

Volvo Car Corporation Gothenburg, Sweden

17

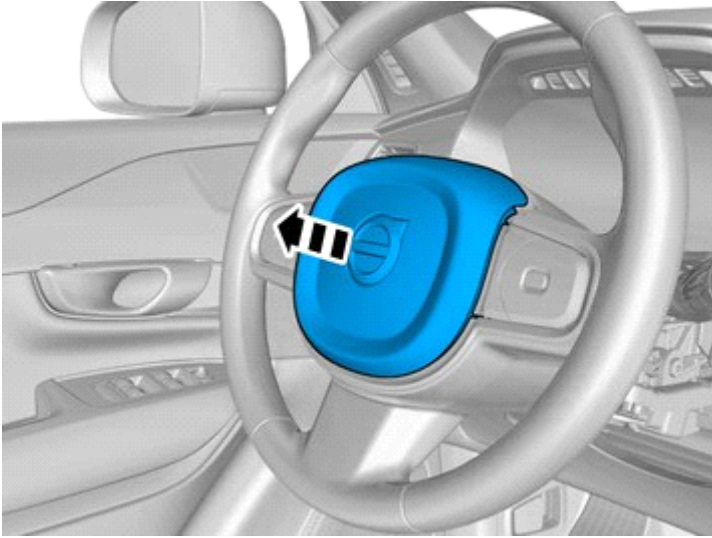

IMG-395397

## Warning!

When temporarily storing a pyrotechnical component, it must always be positioned with its active part (e.g. air bag front or equivalent) facing up.

Remove the marked part.

18

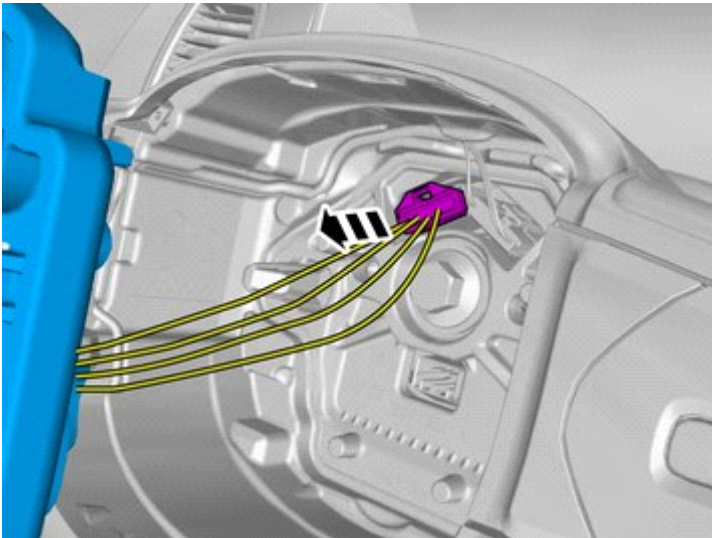

IMG-395457

Disconnect the connector.



# Installation instructions, accessories

Volvo Car Corporation Gothenburg, Sweden

19

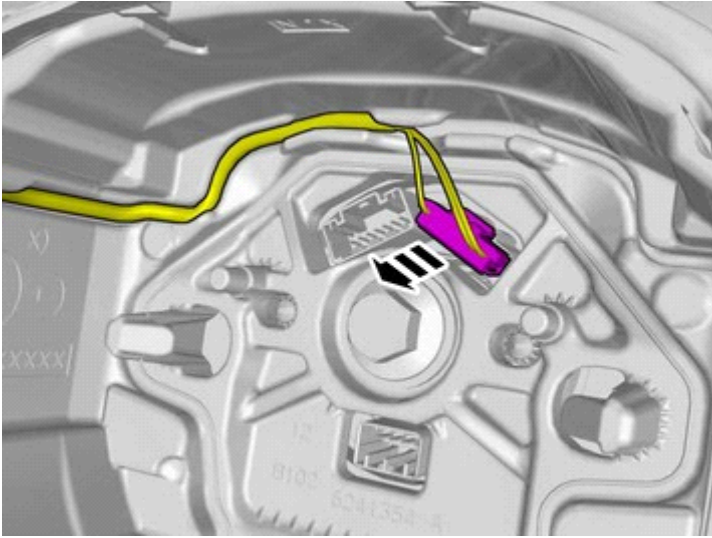

IMG-395470

Disconnect the connector.

20



IMG-395471

Remove the screw.

21

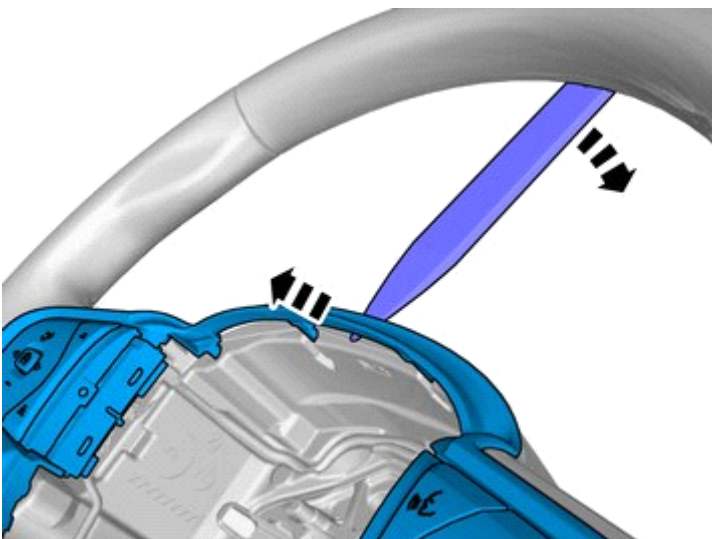

IMG-395670

**Use:** Interior trim remover



# Installation instructions, accessories

Volvo Car Corporation Gothenburg, Sweden

22

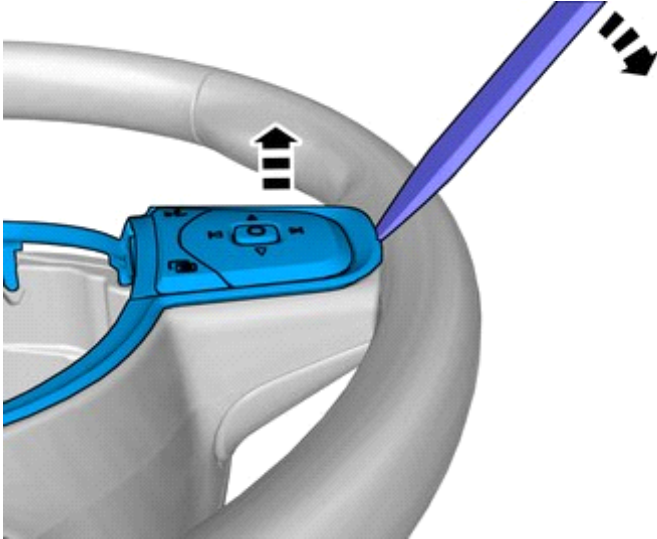

IMG-395671

**Use:** Interior trim remover

23

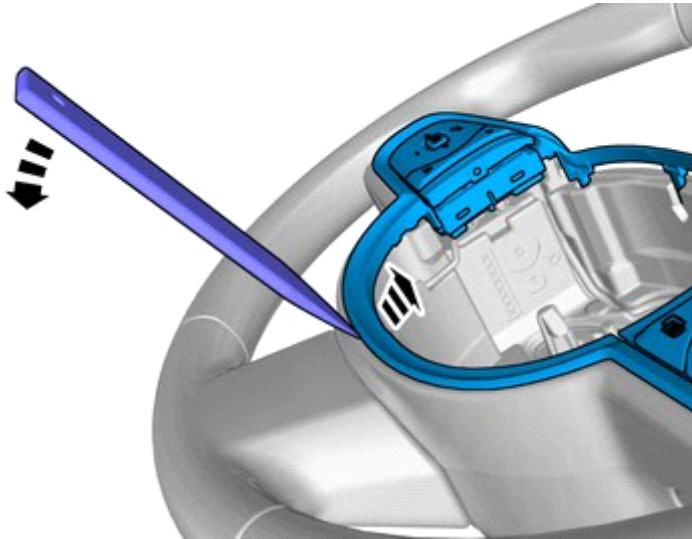

IMG-395681

**Use:** Interior trim remover

24

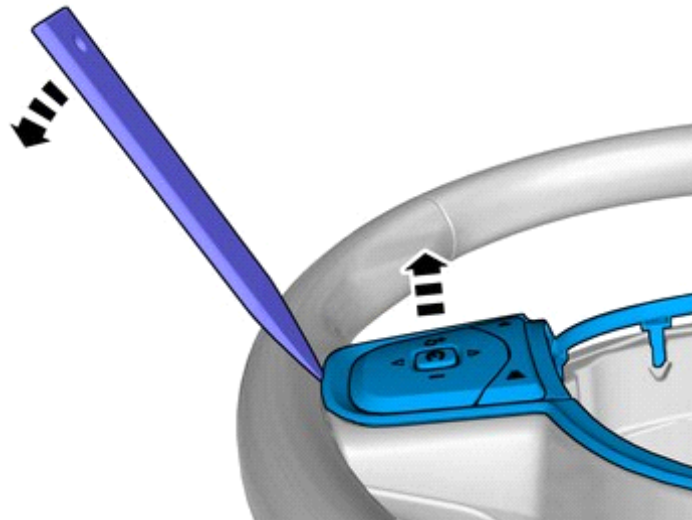

IMG-395682

**Use:** Interior trim remover



# Installation instructions, accessories

Volvo Car Corporation Gothenburg, Sweden

25

Remove the marked part.



IMG-395680

26

Remove the marked part.

Repeat on the other side.

The part is to be reused.

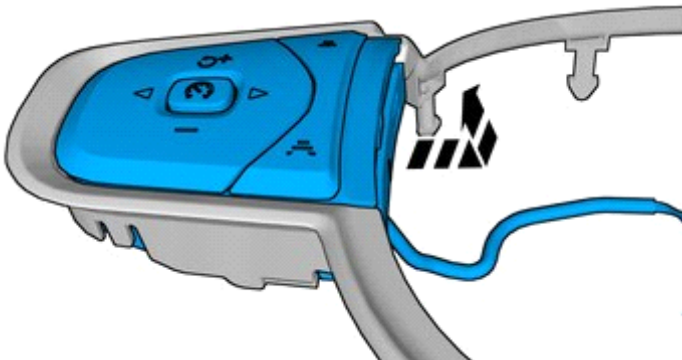

IMG-395701

## Accessory installation



# Installation instructions, accessories

Volvo Car Corporation Gothenburg, Sweden

27

Reuse existing parts.

Repeated on the right-hand side.

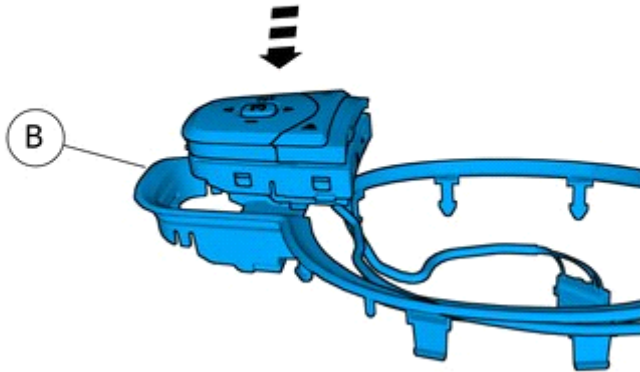

IMG-395805

28

Repeated on the right-hand side.

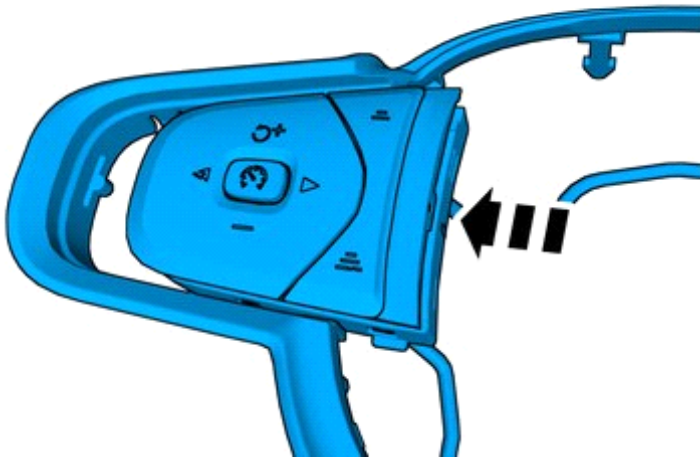

IMG-395806

29

Install component that comes with the accessory kit.

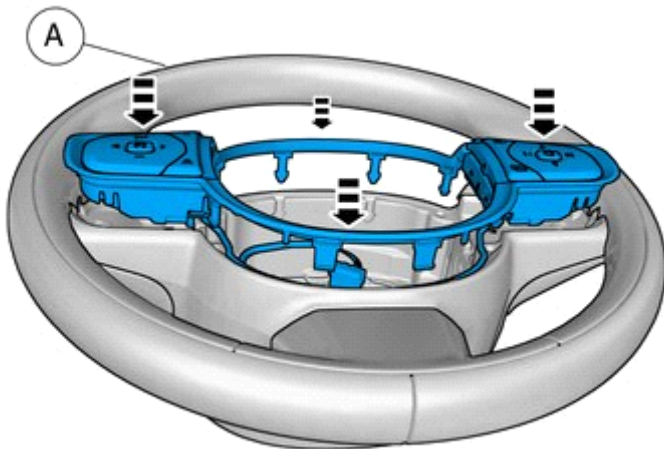

IMG-395811



# Installation instructions, accessories

Volvo Car Corporation Gothenburg, Sweden

30

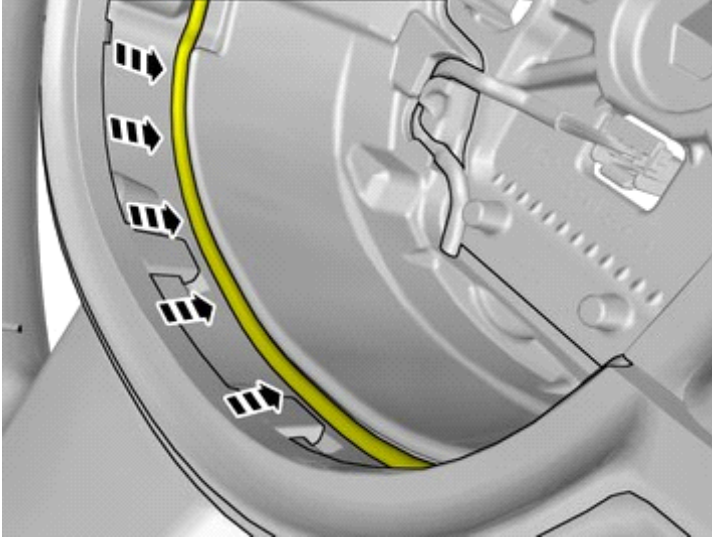

IMG-395820

31

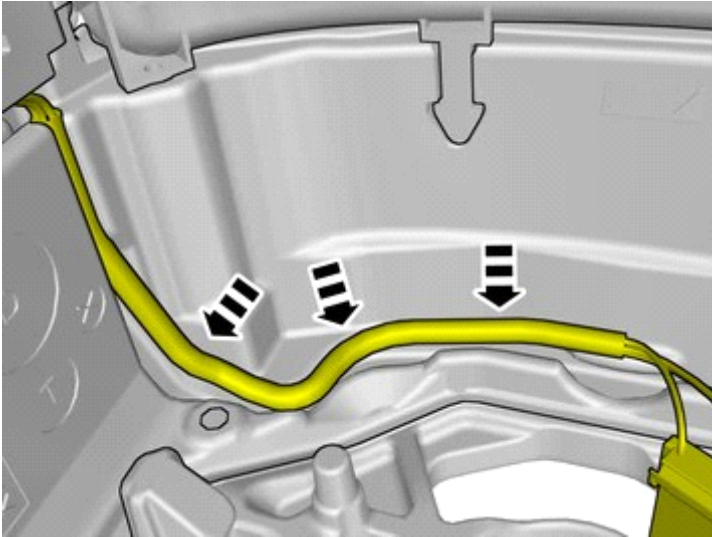

IMG-395825

32

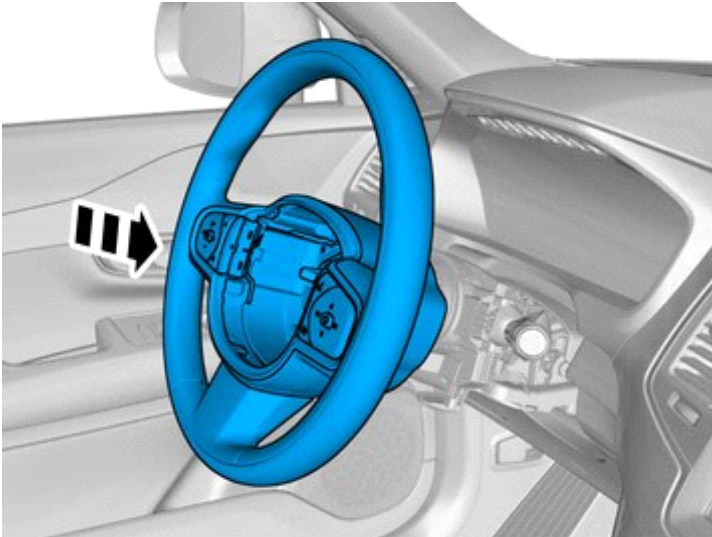

IMG-395945

Install component that comes with the accessory kit.



# Installation instructions, accessories

Volvo Car Corporation Gothenburg, Sweden

33

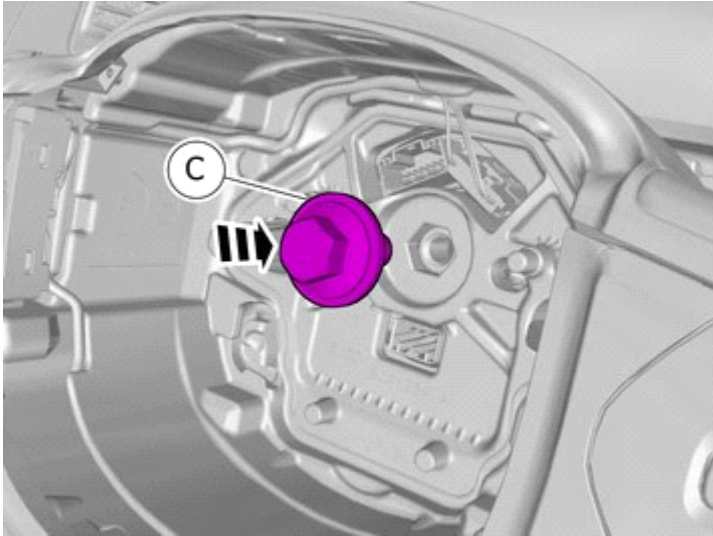

IMG-396154

Install component that comes with the accessory kit.

Tighten the screw.

**Tightening torque:** Steering wheel to steering column (center screw) , 60 Nm

34

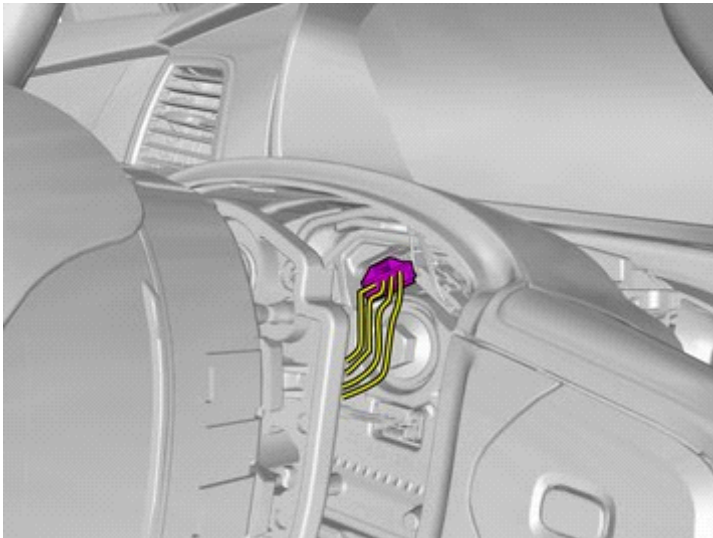

IMG-396035

Connect the connector.



# Installation instructions, accessories

Volvo Car Corporation Gothenburg, Sweden

35

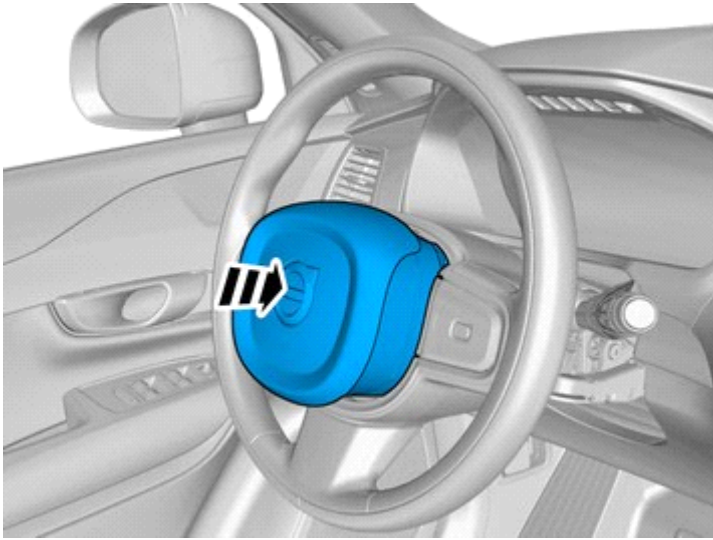

IMG-396040

Reuse existing parts.

A click confirms that the component is in the correct position.

---

## Installation

36

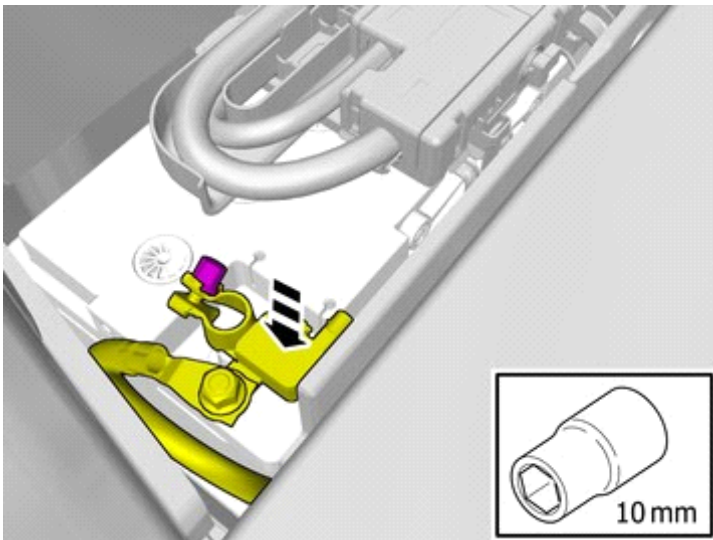

IMG-394580

Reinstall the battery's negative cable.

**Tightening torque:** Battery cable for battery , 6 Nm





# Installation instructions, accessories

Volvo Car Corporation Gothenburg, Sweden

37

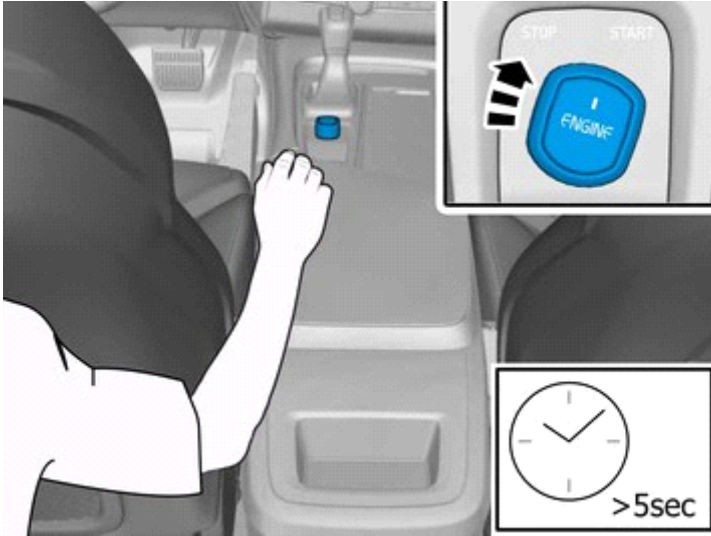

IMG-394531

### Warning!

The first time the vehicle is activated after the battery has been disconnected, this must be performed from the rear seat, avoid the work area for the air bags.

---

### Right-hand drive vehicles

38

When removing on right-hand drive cars, perform the procedures on the opposite side and/or mirrored.

39

When installing on right-hand drive cars, perform the procedures on the opposite side and/or mirrored.

---